

Spherical roller bearings, cylindrical and tapered bore

Principal dimensions			Basic load ratings		Speed ratings	Limiting speed	Designation
d	D	B	dynamic C	static C0	Reference speed		* SKF Explorer bearing
mm			kN		r/min		-
500	720	167	4358	7800	500	900	230/500 CAK/W33 *

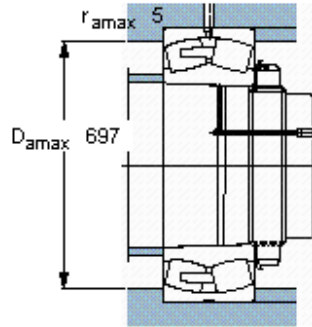
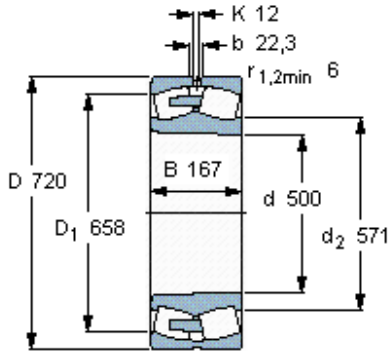

Tapered bore, taper
1: 12

Calculation factors

- e 0,21
- Y_1 3,2
- Y_2 4,8
- Y_0 3,2